

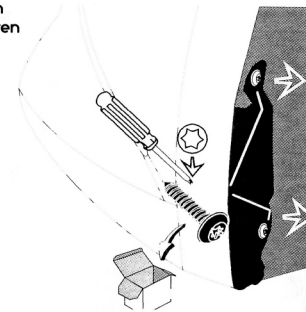

LEON

1 Schrauben demontieren



2 Spoilerlippe anbringen

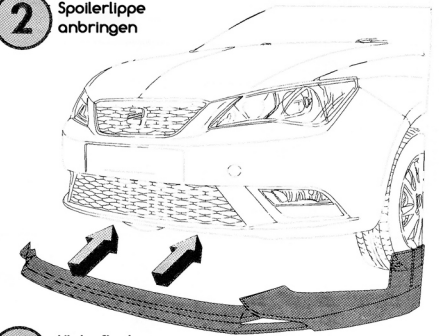

3 Schrauben montieren

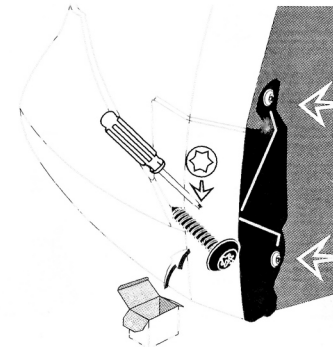

4 Klebeflächen markieren

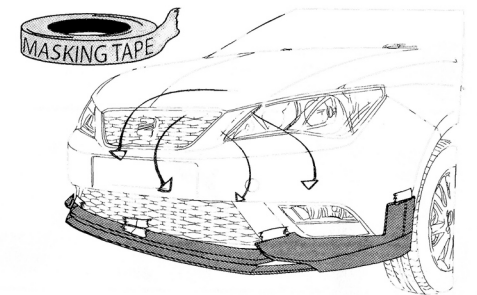

5 Frontspoiler abnehmen

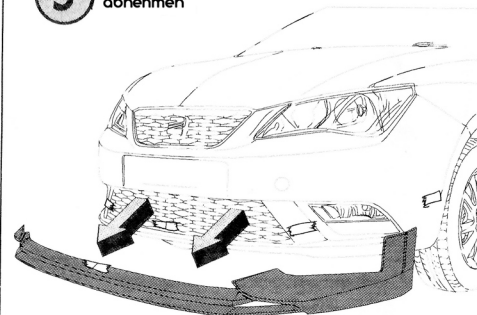

6 Klebefläche reinigen





Accesorios Frontspoilerlippe für Seat Leon (5F)

Art.Nr. 15M001810LE

LEON

7 Reinigen und Kleber auftragen

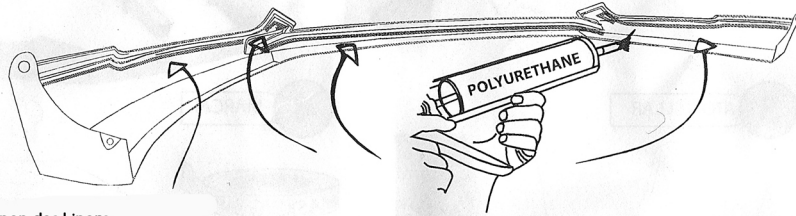
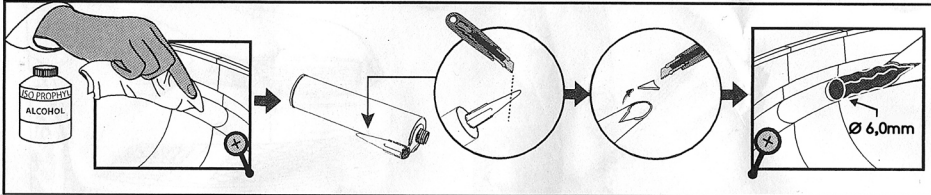

8 Entfernen des Liners

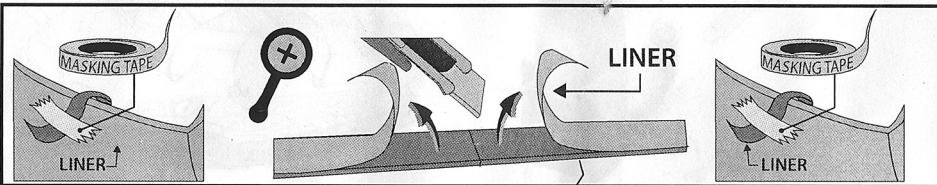

Die Enden des Liners befestigen!

Die Enden des Liners befestigen!

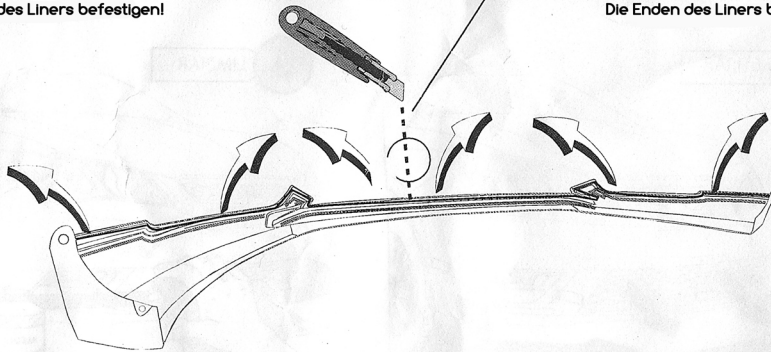

FLS Performance
Optik & Performance Tuning

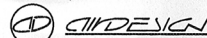

Accesorios Frontspoilerlippe für Seat Leon (5F)

Art.Nr. 15M001810LE

LEON

9 Montieren

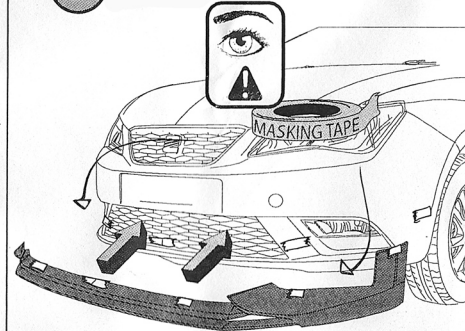

10 Entfernen des Liners

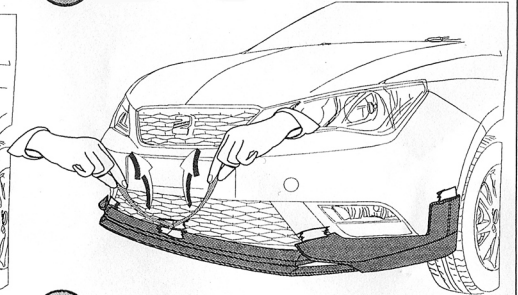

11 Andrücken

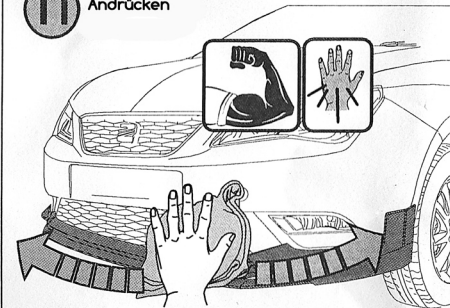

12 Schrauben eindrehen

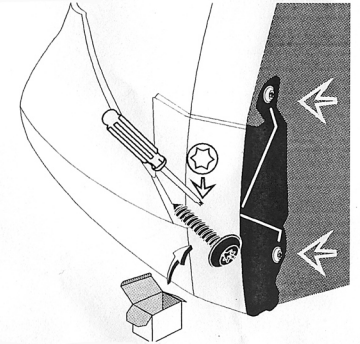

13 Bohren

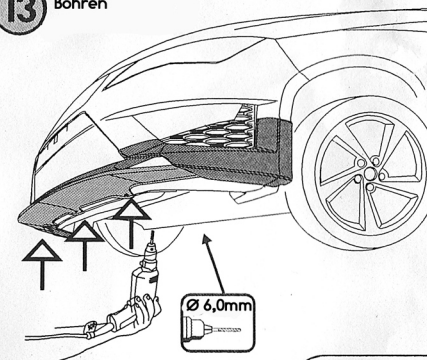

14 Eindrücken

